



Internet Everywhere™

Managing Visitor Based and Subscriber Based Internet Access Networks

Mike Sopko
Interviewee



Our Company

- **CAIS Software Solutions**

- A subsidiary of CAIS Internet, a public company with a market capitalization of \$800 million.
- Company formed in 1995. Employs over 450 people.
- Hospitality market leader with the largest installed room base. Over 200 properties installed with a backlog of 15,000 in the US.
- Installation and technology partners include Unisys, Lucent, 3Com, British Telecom, Microsoft and others.
- Winner of Microsoft® technology, design & industry awards.
- Listed as one of Fortune Magazine’s “25 Coolest Companies!”
- Headquartered in San Diego with installations worldwide.

- **Mission & Markets**

- To be the premier provider of management software for “*Visitor Based Networks*”
- Hotels, MDUs, airports, malls, cruise ships, office buildings, homes & other public venues



The IPORT Solution

The IPORT Solution is a tightly integrated suite of software products allowing for full management of broadband Internet access.

The products provide your customers new amenities, building their satisfaction and enhancing your revenue.



The IPORT Solution

- **The IPORT Suite:**

- **IPORT BPS – Broadband Provisioning System**

- for providing “plug & play” laptop and PC connectivity

- **IPORT PTS – Public Terminal System**

- for reliably managing secure operations on public PCs and kiosks

- **IPORT CMS Services – Central Management System**

- network management for proactive system monitoring and problem diagnosis



IPORT BPS

IPORT Broadband Provisioning System

- “ISP in a Box” – a software server that provisions, tracks, and bills users in a network for accessing the Internet



The Problem (MDU's)

- **The Customer:**
 - Slow, difficult & unreliable Internet connections through “dial up”
- **Property Owners & Service Provider:**
 - Need a competitive advantage
 - Need to generate incremental tenant revenue
 - Desire to capitalize on portal and commerce revenue



The Problem (Hotels)

- **The Customer:**

- Slow, difficult & unreliable Internet connections while traveling
- Expensive long distance phone charges & support issues

- **Property Owners & Management:**

- Declining guest satisfaction & business traveler loyalty
- Overloaded PBX systems requiring additional trunk lines, cards or chassis
- Need a competitive advantage
- Need to attract high-tech meetings, conferences & seminars
- Need to generate incremental guest & meeting room revenue



Other Locations

- Office Buildings
- Lobbies
- Business / Convenience Centers
- Executive Suites
- Conference Centers
- Restaurants and Shopping Centers
- Airport / Train terminals
- Homes
- Cruise Ships



“Travelers will select hotels & other public venues that have fast, easy & inexpensive access to the Internet.”



IPORT™ BPS Features

- The Four P's of IPORT

- Plug & Play
- Provisioning
- Policy
- Portal

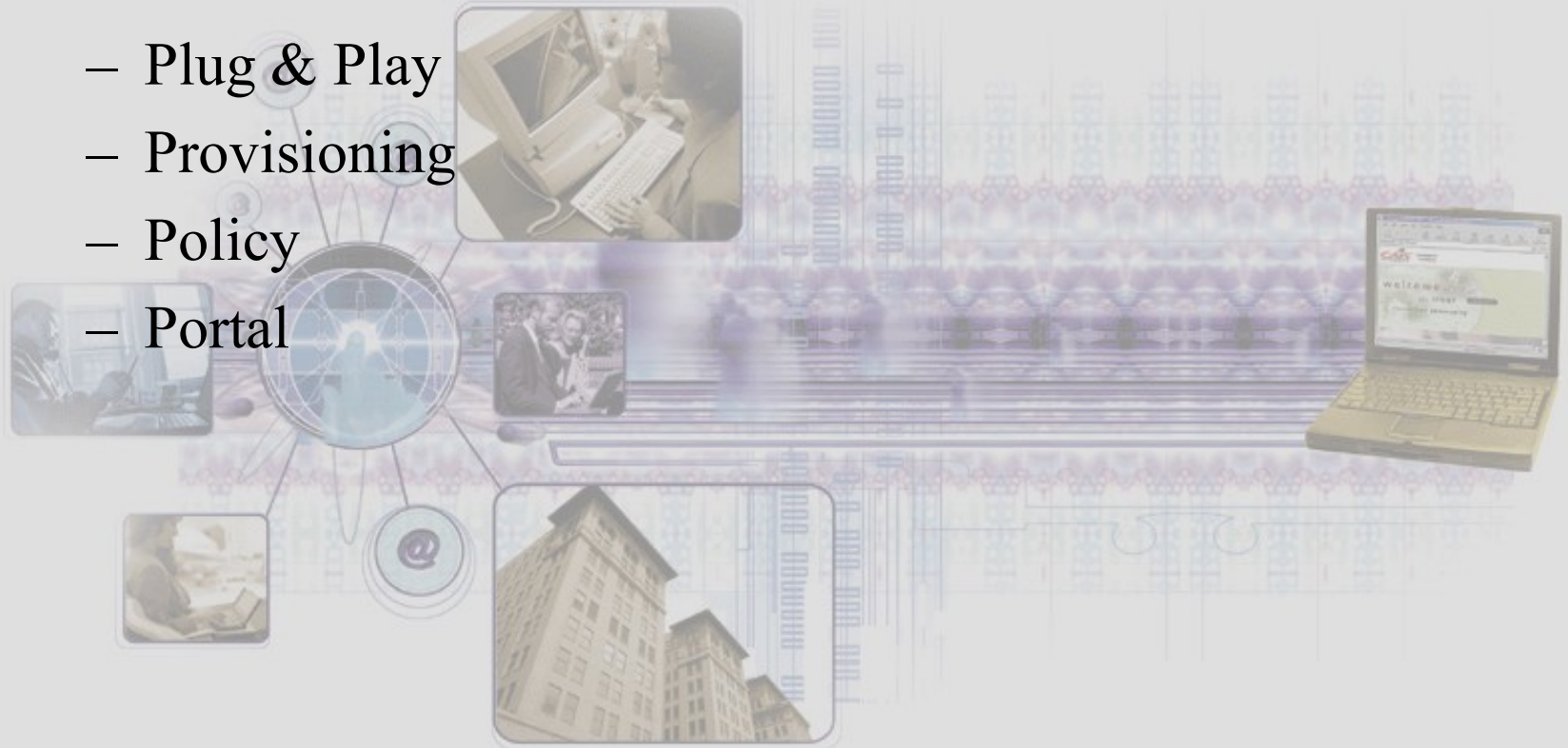

IPORT™ BPS Features

- Plug & Play
 - No client software needed
 - No reconfiguration of user's computer
 - End-user simply plugs laptop's Ethernet cable into IPORT jack and launches web browser
 - Client DHCP or static IP OK



IPORT™ BPS Features

- Provisioning
 - User can self-provision service
 - Service time
 - Allocated bandwidth

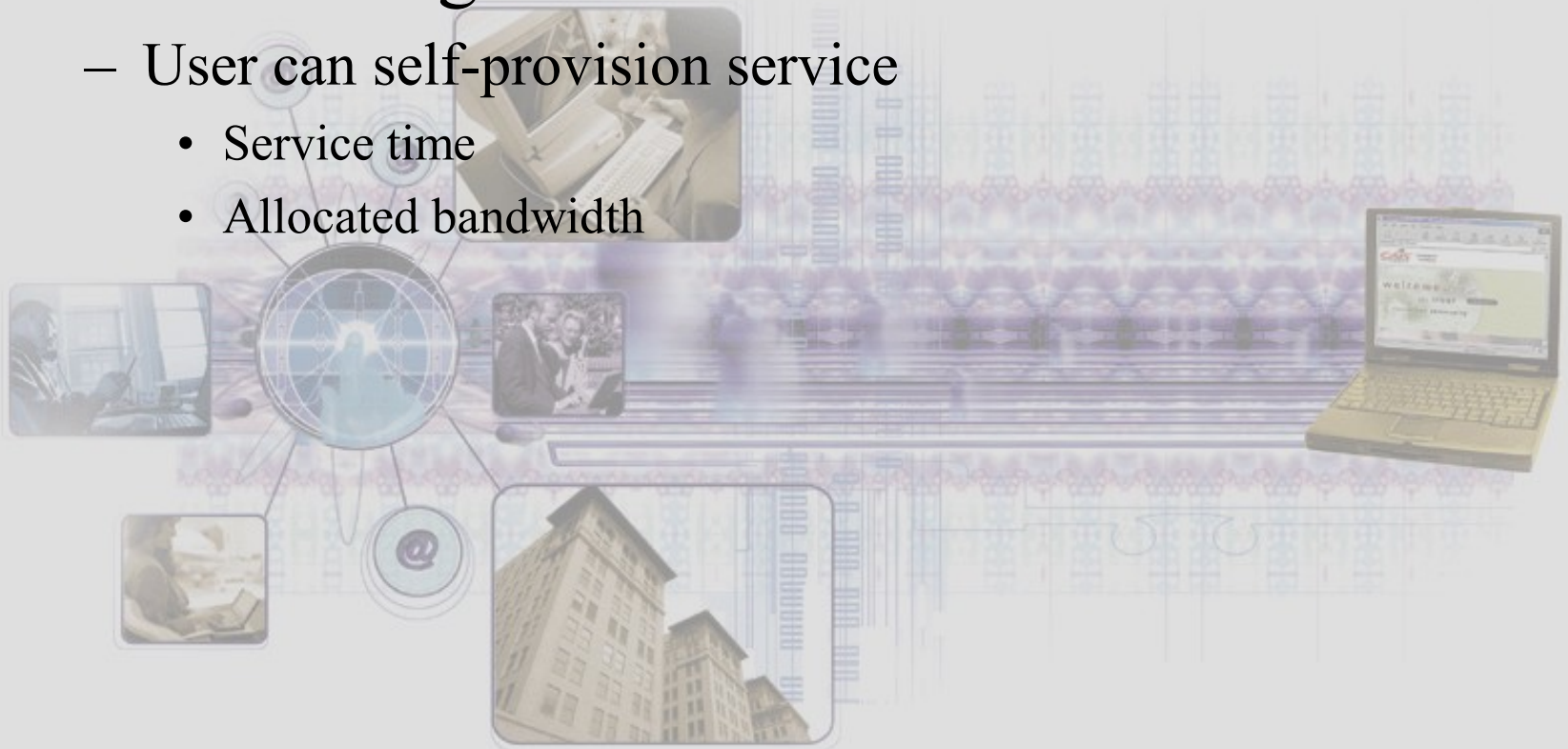

IPORT™ BPS Features

- Policy

- Create a custom policy for each individual port

- Price
- Billing Method
- Customized web screen

“Personalize and localize because you know who and where the customers are.”



IPORT™ BPS Features

- Portal

- Redirect user to custom portal
- Customize interface for a specific user or group
- Web Zones
 - Free access to the Intranet
 - Create custom zones
- E-Commerce enabled

“Redirect users through connect web pages that expose them to content specified by the service provider.”



Web Zone I - Property

ENTERING
WEB ZONE
I

Welcome to the CAIS/ATCOM Intranet - Microsoft Internet Explorer

File Edit View Favorites Tools Help

Back Forward Stop Refresh Home Search Favorites History Mail Print Edit RealGuide

Address <http://intranet/new/index.asp> Go Links

CAIS
INTRANET

Welcome to the Intranet

Microsoft Investor custom update CAIS 14.75 -1.25 MU 67.88 -2.13 MXWL 11.00 +0.19 SBU

atch news as it breaks Video news: NBC, MSNBC, CNBC reports The

You can customize your stock ticker to show CAIS stock and others, just click the CUSTOM button and follow the directions.

A New Look, A New Direction, A New Era
Well, how do you like the new look? With the recent merger of ATCOM/INFO and CAIS Internet, an old chapter has been closed and a new chapter begins. In less than a month ATCOM/INFO will begin to move to the new building at 600 B Street, Suite 1800. This is the start of a new era for the company. hope you're all ready!

Find A Friend, Get Some Cash!
Steve Nye has recently implemented a "CASH BACK" program for people who can recruit new employees. You can earn up to \$1000 for each person that is hired. More...

Any Ideas?
Do you have any ideas about what should be displayed on the Intranet. Send us an E-mail at intranet@atcominfo.com. Everybody's opinion matters, even yours!

ATCOM/INFO will observe Monday the 6th of Sept. in honor of Labor Day.
Enjoy!

LABOR Day

©Copyright 1999
CAIS Software Solutions

Last update: August 26, 1999
©1999 CAIS Software Solutions. All rights reserved.
Contact the webmaster for comments, questions, or concerns.

Microsoft Internet Explorer In order to make sure you are seeing this web site as it was intended, YOU MUST use Microsoft Internet Explorer v4.01 or higher.

Done Local intranet



Web Zone II - Portal

ENTERING
WEB ZONE
II

Welcome to the IPORT Connected Community - Microsoft Internet Explorer

File Edit View Go Favorites Help

Back Forward Stop Refresh Home Search Favorites History Channels Fullscreen

Address <http://design/iptorconnected.asp> Links

IPORT
connected community

ACME Hotels

Welcome back to San Diego,
Ethan LaPan

join
connected
community

get personalized content

special offers

access to channels and
bulletin boards

SPORTS

BUSINESS NEWS

NEWS

MUSIC

TECHNOLOGY

IPORT quarter

MOBILE office tools

BUSINESS center

IPORT locations

JOIN connected community

disconnect

Local intranet zone



Web Zone III - Internet

ENTERING
WEB ZONE
III

The image shows three overlapping web browser windows. The top-left window is the Wall Street Journal (WSJ.com) homepage, dated May 18, 1999. It features a 'SUBSCRIBE NOW!' banner, a 'Go to Interactive Journal' link, and a 'Read the Latest News' section with links to 'Industrials Retreat From Early Rally After Fed Leaves Interest Rates Steady' and 'SEC Censures, Fines Datek Online for Mis'. A 'The Markets' section includes a line graph for the Dow Jones Industrial Average and Nasdaq S & P 500. The top-right window is MSNBC.com, displaying a 'Technology' article titled 'You look marvelous' with a sub-headline 'New games for the PC are spiffy if unoriginal - By Steven Kent' and a 'Technology Index' section. The bottom window is FOX Sports.com, featuring a 'Torre story at Fenway' article about Pedro Martinez and David Cone, a 'FEATURES' section for 'NBA PLAYOFFS', and a 'FOX VIEWS' section with 'KEVIN KENNEDY ON BASEBALL' and 'Ancient rivalry resumes'. A navigation menu at the top of FOX Sports.com lists various sports categories like Baseball, Basketball, Football, etc.

IPORT™ BPS Features

- Other features

- Property wiring neutral
- PMS interface
- Central office solution
- Compliant with Radius authentication
- Corporate VPN compliant (IPSEC, PPTP, L2TP)
- Credit card clearing capable
- Reporting tools and modules
- Runs on Microsoft NT and Back Office Suite

Reliable and Market Proven



IPORT™ BPS Companion Products

- Network Management Tools
- Network Print Manager
- Integrates with IPORT PTS and IPORT CMS
- Meeting Room Manager (add-on option)



IPORT™ BPS Services & Support

• IPORT™ Services & Support

- 24x7 User Help Desk Support
- 2nd Level VAR & OEM Support
- Remote Diagnostics & Monitoring
- Remote Software Upgrades
- Remote Web Page Enhancements
- Remote Network Management
- System Usage Reporting
- Technical & Customer Training
- Web Page Development
- Credit Card Clearing Services
- Software Customization & Integration



High Speed Internet Access

Setting the standard
for high-speed Internet
access worldwide.

IPOINT
Internet Access System

How else can you get
INTERNET EVERYWHERE?



How It Works

Basic MDU Wireless Transmission Configuration

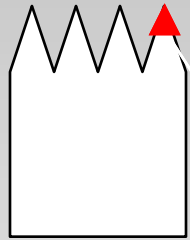

Wireless Transmission Criteria:

- Must have 110 Volt a power source.
- Must have a Separate Grounding source.
- Must have a CAT-5 cable used for input to
- Main Distribution Switch.
- Must have a lightening arrestor installed

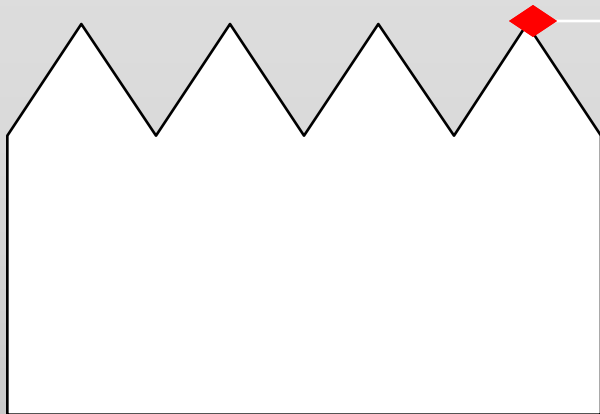

•Typical Main Antenna View



How It Works

MDU utilizing a Wireless Antenna Distribution

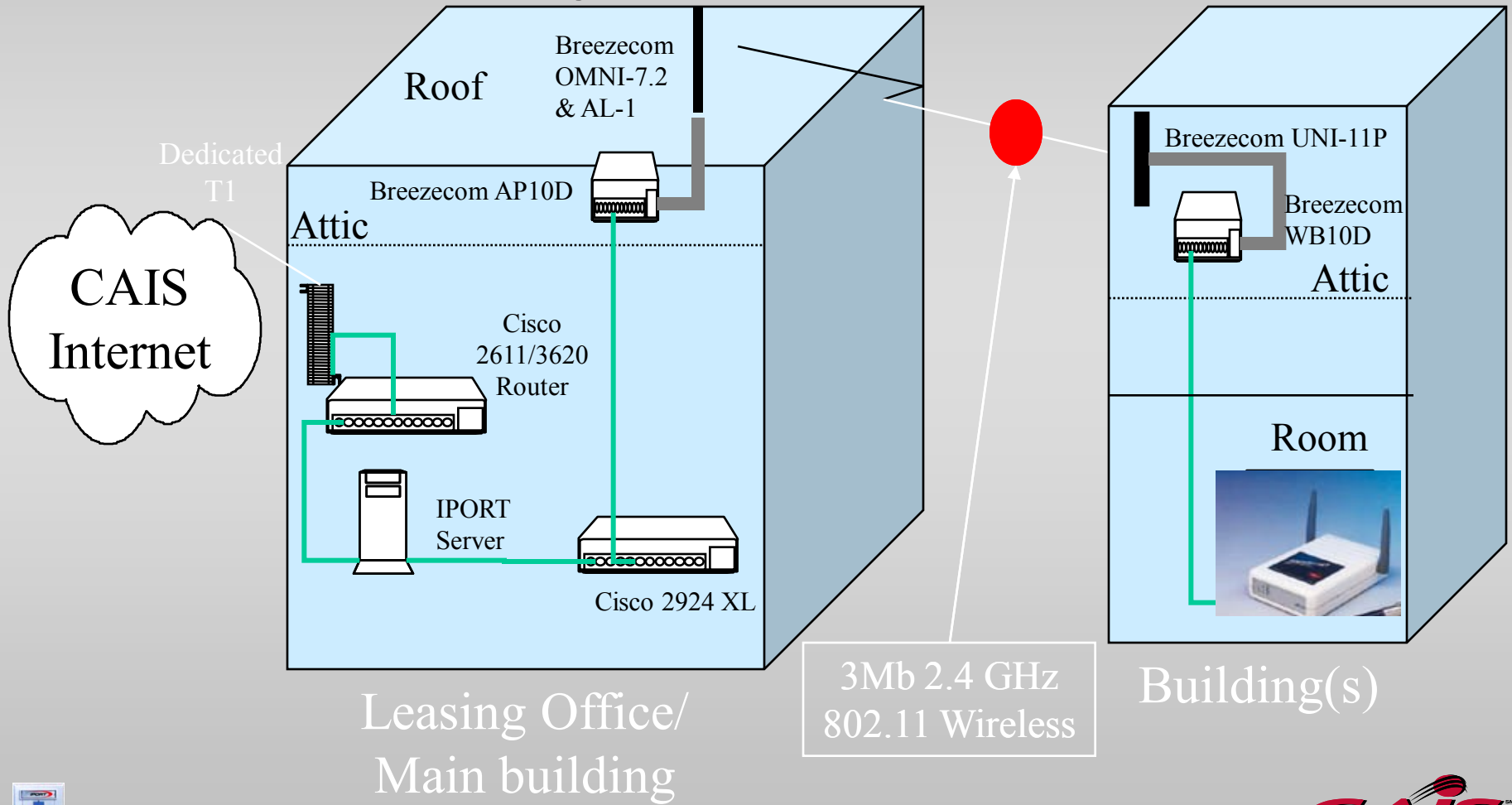

How It Works

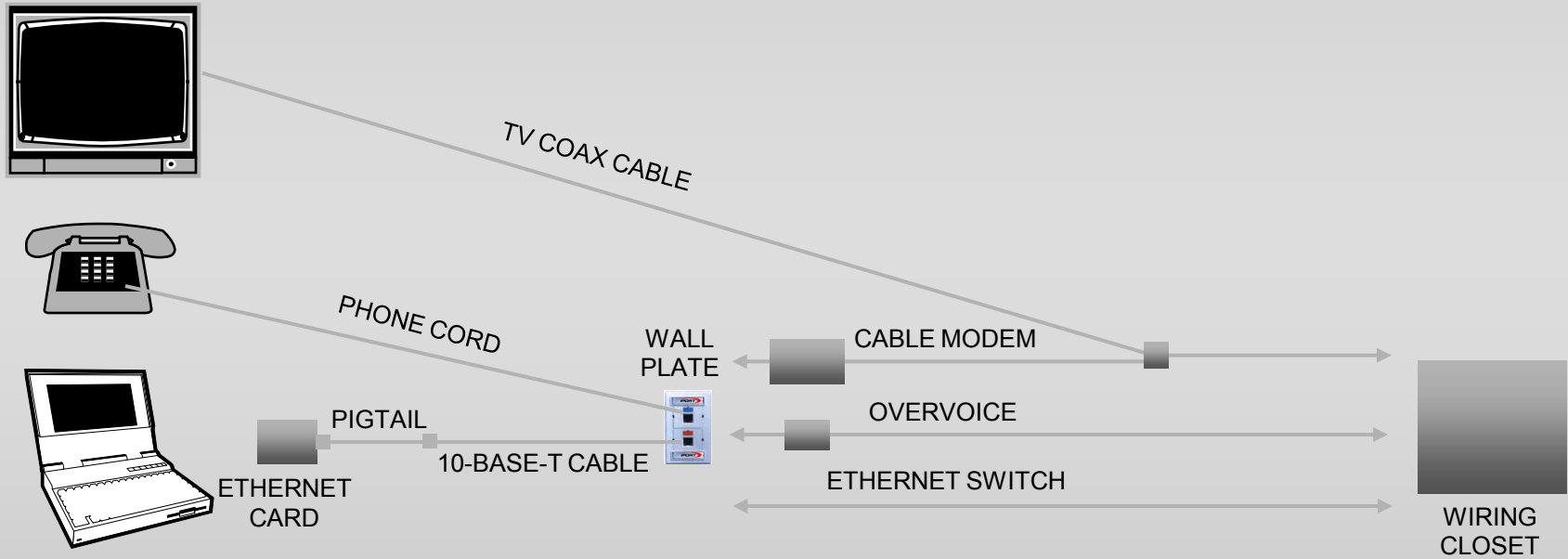

How It Works

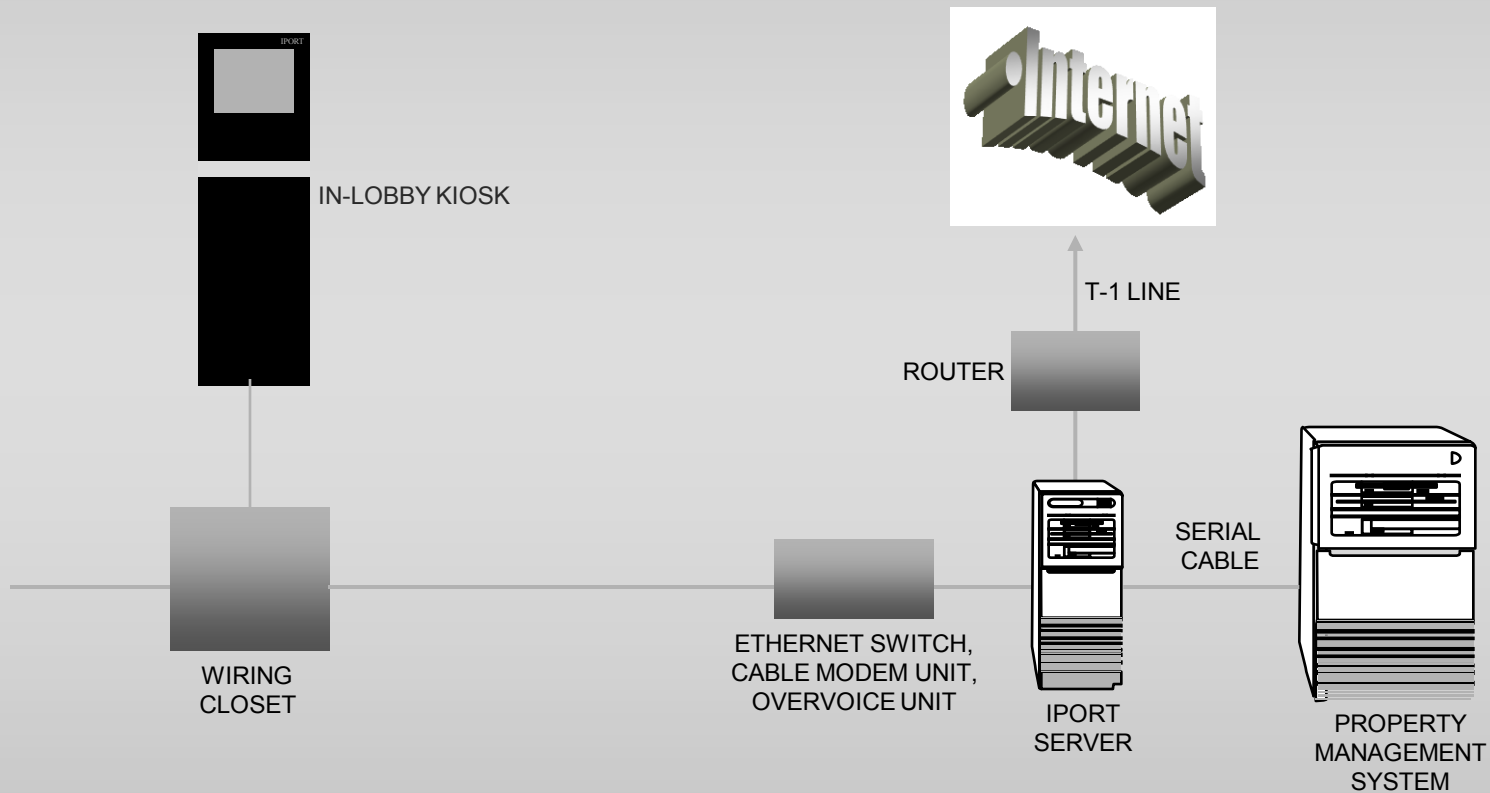

Benefits of IPORT BPS

For the End User:

- IPORT BPS helps increase productivity while away from the office
- User can quickly and easily access the Internet, browse at speeds 50 times faster than a modem, and even make on-line purchases



Benefits of IPORT BPS

For the End User:

- Fast and easy set-up
- Increased productivity due to high connection speed
- E-commerce support
- Walled Gardens (intranet web sites and other links that can be accessed by users before they agree to pay or authenticate)
- VPN compatibility



Benefits of IPORT BPS

For the Property or Service Provider:

- Helps offload dial-up Internet users from hotel property's PBX system
- Increased Revenue through web-page branding
- Lowered Administration and Support Costs
- Provides a Value-Added Service to differentiate from competitors



Benefits of IPORT BPS

For the Property or Service Provider:

- IPORT BPS enables service providers to use a web-based platform to activate broadband Internet sessions. In this content-focused world, having a policy-based web system to authenticate, account, and authorize each session maximizes the power to deliver future value-added services on top of the high-speed pipe.



Competitive Advantages of IPORT BPS

IPORT BPS stands out from the competition in the following ways:

- **Per Port Policy**
 - Pricing, Billing, Web Page, Bandwidth
- **Reporting**
 - User statistics, usage, and revenue reports on a per-room or per-terminal basis
- **Scalability**
 - Central office architecture for multiple properties
 - Can handle up to 2000 concurrent sessions with average Internet usage, or 5000 ports per server



IPOINT™ PTS

IPOINT Public Terminal System

- Software for revenue assurance and terminal management for public PCs or kiosks
- A “shell” that replaces the Windows shell on the Windows NT Workstation operating system



IPOINT™ PTS Locations

- Airports and Public Areas
- Hotels
- Executive Suites and Office Buildings
- Conference and Business Centers
- Restaurants and Cafes
- Shopping Malls
- Tourist Attractions
- Truck Stops
- Cruise Ships



IPORT™ PTS Features

IPORT PTS Components:

- IPORT PTS Software (4 modules)
- Windows NT operating system
- Base PC computer and monitor
- Form Factor for kiosk casing or shell (optional)
- Hardware accessories such as printers, card readers, or bill collectors (optional)



IPORT™ PTS Features

- **IPORT PTS Software Modules:**

- Core Internet Module
- Peripheral Module
- Access Module
- Application Integration Module



IPORT™ PTS Features

- Core Internet Module

- Provides Carrier Class security of the operating system
- A proprietary browser which supports major plug-ins and restricts access to the hard drive or operating system
- Provides PC freeze prevention so the terminal is always on
- Allows great flexibility in interface design and custom screen savers and attract loops
- The Clean Routine clears the PC of cookies, links etc. upon session termination
- Provides communication software to facilitate CMS functions (explained in the CMS section)



IPORT™ PTS Features

- Peripheral Module

Allows the terminal to support common peripherals such as:

- Printers
- Receipt or ticket printers
- Scanner
- Video camera
- Floppy drive access

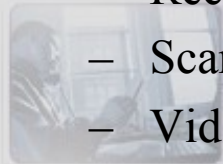

IPORT™ PTS Features

- Access Module

Allows for the terminal to be activated through the following methods:

- Mag stripe card (credit card, pre-paid card, etc.)
- Smart card
- Bill acceptor

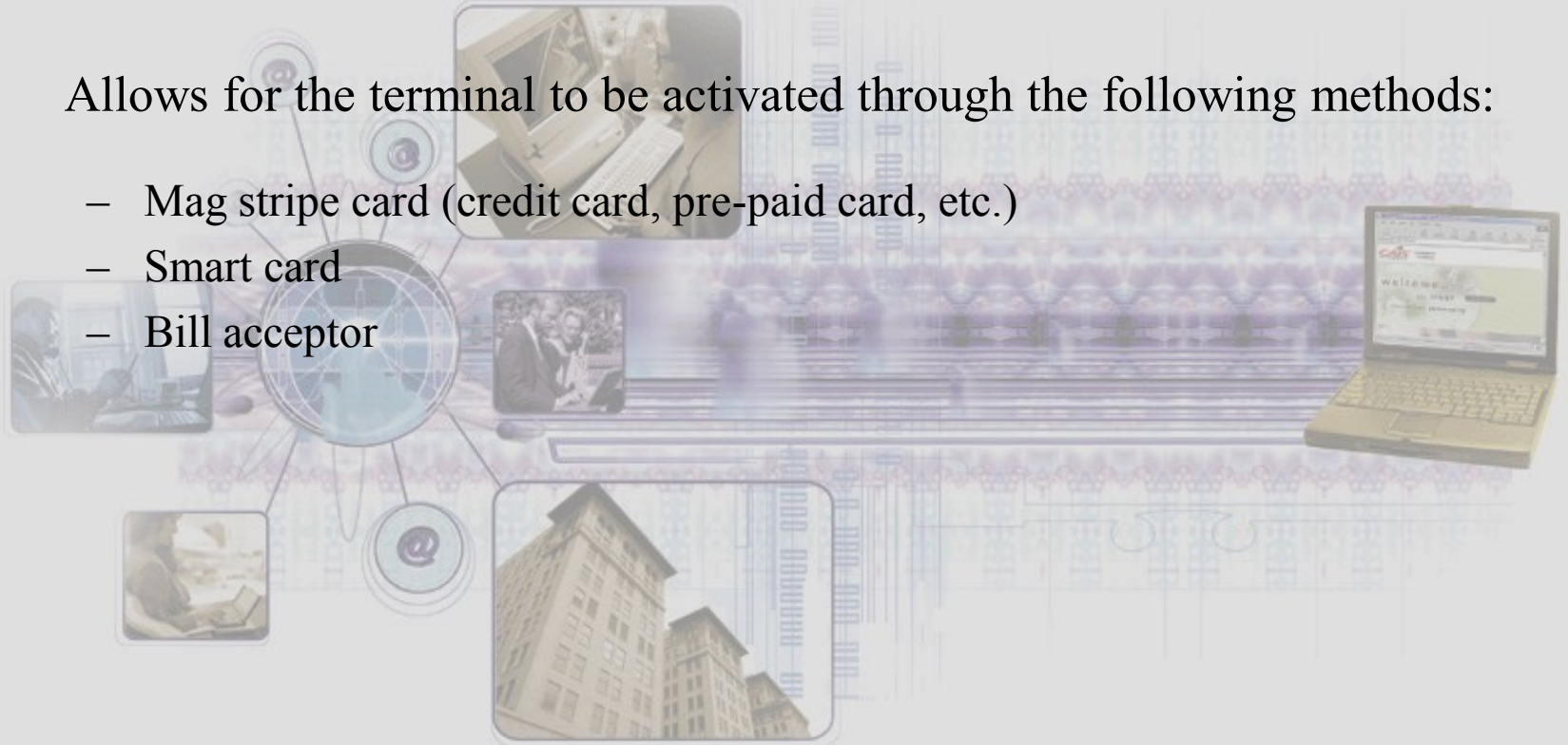

IPORT™ PTS Features

- Application Integration Module

Allows for third party applications to be integrated in the secured PTS environment. Supported applications include:

- Microsoft Office (Word, Excel, PowerPoint)
- Lotus SmartSuite (123, WordPro, Freelance, Approach)
- Corel WordPerfect Suite (WordPerfect, Quattro Pro)
- Corel Draw desktop publishing



IPORT™ PTS Multimedia Attract Loop

What's inside your computer?

TO START:
Move the mouse to your desired option and select it.

You will be prompted to swipe your access card or credit card.

TO FINISH:
Select the EXIT button to stop using the IPORT™ Business Center & stop charging.

IPORT BUSINESS CENTER

APPLICATIONS E-MAIL THE INTERNET TRAVEL SERVICES ONLINE SERVICES CHARGING OFF

Microsoft Office [E-mail icon] [Internet icon] [Travel icon] [Online icon] EXIT HELP

Lightning Fast Internet





IPORT™ PTS Interface

What's inside your computer?

IPORT BUSINESS CENTER

CHARGING OFF

APPLICATIONS E-MAIL THE INTERNET TRAVEL SERVICES ONLINE SERVICES EXIT HELP

Microsoft Office

IPORT™

Welcome to the IPORT™ Business Center

How to get started

*Touch the mouse to move the mouse cursor around the screen.
Select an option by clicking on it.*

TO START:
Move the mouse to your desired option and select it.

You will be prompted to swipe your access card or credit card.

TO FINISH:
Select the EXIT button to stop using the IPORT™ Business Center & stop charging.



IPORT™ PTS Availability

Options for customers whose requirements cannot all be met by the IPORT PTS CD-ROM alone:

- “Standard Packs” (software integrated with necessary hardware and delivered to the customer):
 - Retail Kiosk
 - Hospitality Kiosk
 - Hospitality Managed PC
 - Business Center Managed PC
- “Flex Packs” (customizable)



Benefits of IPORT PTS

For the End User:

- IPORT BPS helps increase productivity while away from the office
- User can quickly and easily access the Internet in public places, browse at speeds 50 times faster than a modem, and even make on-line purchases



Benefits of IPORT PTS

For the Property or Service Provider:

- Increased Revenue through web-page branding and specific user segment targeting
- Lowered Administration and Support Costs – an unattended public terminal solution which can be managed remotely
- Provides a Value-Added Service to differentiate from competitors



Competitive Advantages of IPORT PTS

IPORT PTS stands out from the competition in the following ways:

- **Security**
 - Designed for unattended locations
- **E-Commerce Capabilities**
 - Payment for web content and services
- **Central Management**
 - Remote monitoring, reporting, upgrading, authentication, and billing



IPORT™ CMS

Fully Scalable Central Management System

- **As an IPORT™ PTS Companion**
 - Restart after power surges, outages or other system disruptions
 - Automatic error detection & recovery
 - Remote interface & content management
 - Credit or access card clearing
- **As an IPORT™ PTS and IPORT™ BPS Companion**
 - Daily user statistic reporting
 - Remote error reporting & logging
 - Remote state-of-health monitoring
 - Remote application & system upgrades



IPORT™ CMS

- **Other Features**
 - Web-based network management system
 - Page & email field service engineers
 - High Availability & Low Maintenance Expense
 - Based on a Microsoft Windows NT Platform



Business Anywhere

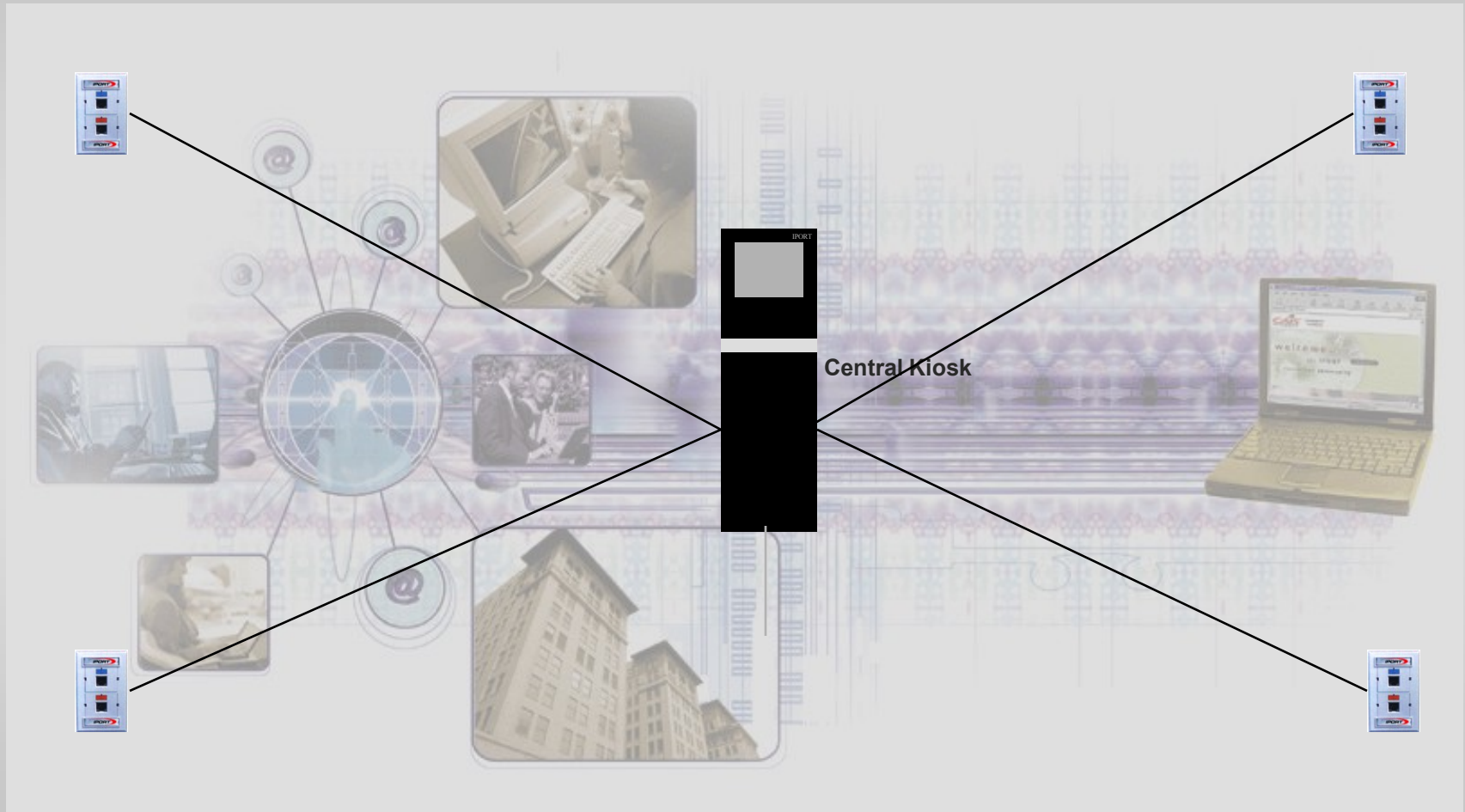

Our Partners

SAIC® MTT® 3Com® Royal Caribbean®
Siemens® Cabletron® Magiweb®
TUT Systems® Com21® US West®
IBM® KIS® Microsoft®
Rikei® Pacific Bell® CAIS Internet®
Interquest® OnCommand®
MCI Worldcom® Lucent®
British Telecom® NCR®



IPORT™ Customers Worldwide

- 1.1 million Hotel Rooms
- 9000 Properties
- 575 Apartment Communities
- 200,000 Residences



Our Customers

Four Seasons Beverly Hills Westin Seattle Homestead Village, Bellevue
Holiday Inn, Minneapolis Doubletree Orange County San Diego Airport
Marriott Minneapolis San Ramon Marriott Summerfield Suites
Tucson Airport SeaTac Airport Loews Miami Beach
Oakwood Apartments, Bellevue Holiday Inn Crown Plaza, Taiwan
Sheraton Hotel, Seattle Hilton Minneapolis Park Place Ramada Renaissance
Wyndham Chicago Hyatt San Jose Airport Century Hyatt, Tokyo
Sterling Point, Layton Marriott Sea-Tac Airport Prince George Hotel, Halifax
Washington Marriott Courtyard Hotel, Denver Hyatt Regency Bellevue
La Guardia Airport Hyatt San Diego Mall of the Americas
Dayton Marriott Denver Marriott Holiday Inn Express, Mexico
Kansas City Airport Northland Inn, Bloomington Harbor Beach Marriott
Ameritel Inn, Boise Greenbelt Marriott DFW Airport
La Jolla Marriott Bellevue Courtyard Wingate St. Louis
Adam's Market, Denver Park Place Suites Sterling Green Apartments
Regal Hotel, Minneapolis Staybridge Suites, Alpharetta Denver Airport
Westchester Marriott



Final Notes

- IPORT BPS current version 4.2
- IPORT PTS current version 4.0
- IPORT products include a 90-day warranty period
- 9000 Properties
- CAIS Software Solutions provides 24 x 7 technical support

"Thank you for your interest and attention!"

